

- UP-Produkte
Verlängerung 28 mm -
Artikelnummer: 12 177 970 90

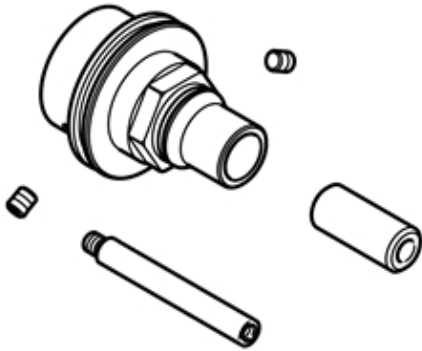

- für xTOOL Thermostatmodul 35 503 / 511 / 521 / 531 / 524 / 534 970 90

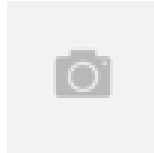

Alle Angaben in mm / inch = mm x 0,0394



- UP-Produkte
Verlängerung 28 mm -
Artikelnummer: 12 177 970 90